



TOOLBOXES & WORKBENCHES

CATALOGUE

CURRENT AS OF MAY 2024





TABLE OF CONTENTS

1 **WORKSHOP TOOLBOXES**

1 Chests & Cabinets

5 **WORKBENCHES**

5 Small & Large Workbenches

7 **SHADOW BOARDS**

8 Shadow Board Accessories

9 **UTE & SERVICE TOOLBOXES**

9 Powder Coated Toolboxes

11 Aluminium Chequer Plate Toolboxes

13 **TRUCK & TRAILER TOOLBOXES**

13 Powder Coated & Polished

15 Angled Under Deck Toolboxes

16 Horizontal Opening Toolboxes

17 Linkwing Toolboxes

18 Aluminium Body & Brushed Finish Door Toolboxes

19 Part Accessories / Hinges / Locks & Key Sets

23 Castor Wheels / Gas Struts / Drawer Sliders / Toolbox Doors

MIKES TRANSPORT WAREHOUSE

WORKSHOP TOOLBOXES



WORKSHOP TOOLBOXES

CHESTS & CABINETS



MTW 5 DRAWER TOOLBOX CHEST

Toolbox pairs with #12593

| | |
|-------------|--------------------------|
| CODE | 12596 |
| SIZE | 673mmL × 471mmD × 428mmH |



MTW 5 DRAWER TOOLBOX CHEST

Toolbox pairs with #12594

| | |
|-------------|--------------------------|
| CODE | 12597 |
| SIZE | 673mmL × 471mmD × 428mmH |



MTW 5 DRAWER TOOLBOX CHEST

Toolbox pairs with #12595

| | |
|-------------|--------------------------|
| CODE | 12598 |
| SIZE | 673mmL × 471mmD × 428mmH |

WORKSHOP TOOLBOXES

CHESTS & CABINETS



MTW 6 DRAWER TOOLBOX CABINET
Toolbox pairs with #12596

| | |
|-------------|--------------------------|
| CODE | 12593 |
| SIZE | 673mmL × 471mmD × 711mmH |



MTW 6 DRAWER TOOLBOX CABINET
Toolbox pairs with #12597

| | |
|-------------|--------------------------|
| CODE | 12594 |
| SIZE | 673mmL × 471mmL × 711mmH |



MTW 6 DRAWER TOOLBOX CABINET
Toolbox pairs with #12598

| | |
|-------------|--------------------------|
| CODE | 12595 |
| SIZE | 673mmL × 471mmD × 711mmH |



MTW 7 DRAWER TOOLBOX CHEST
Toolbox pairs with #12556B-BLACK

| | |
|-------------|---------------------------|
| CODE | 12556-BLACK |
| SIZE | 1423mmL × 610mmD × 533mmH |



MTW 7 DRAWER TOOLBOX CHEST
Toolbox pairs with #12556B-BLUE

| | |
|-------------|---------------------------|
| CODE | 12556-BLUE |
| SIZE | 1423mmL × 610mmD × 533mmH |



MTW 7 DRAWER TOOLBOX CHEST
Toolbox pairs with #12556B-RED

| | |
|-------------|---------------------------|
| CODE | 12556-RED |
| SIZE | 1423mmL × 610mmD × 533mmH |



MTW 11 DRAWER TOOLBOX CABINET
Toolbox pairs with #12556B-BLACK

| | |
|-------------|----------------------------|
| CODE | 12556B-BLACK |
| SIZE | 1828mmL × 760mmD × 1143mmH |



MTW 11 DRAWER TOOLBOX CABINET
Toolbox pairs with #12556B-BLUE

| | |
|-------------|----------------------------|
| CODE | 12556B-BLUE |
| SIZE | 1828mmL × 760mmD × 1143mmH |



MTW 11 DRAWER TOOLBOX CABINET
Toolbox pairs with #12556B-RED

| | |
|-------------|----------------------------|
| CODE | 12556B-RED |
| SIZE | 1828mmL × 760mmD × 1143mmH |

WORKSHOP TOOLBOXES

CHESTS & CABINETS



MTW 3 DRAWER TOOLBOX CHEST
Toolbox pairs with #15250

| | |
|-------------|---|
| CODE | 15249 |
| SIZE | 670mmL × 440mmD × 480mmH (0.8mm thickness) |



MTW 5 DRAWER TOOLBOX CABINET
Toolbox pairs with #15249

| | |
|-------------|---|
| CODE | 15250 |
| SIZE | 680mmL × 450mmD × 860mmH (1.2mm thickness) |



MTW 8 DRAWER TOOLBOX CHEST
Toolbox pairs with #15252

| | |
|-------------|--|
| CODE | 15251 |
| SIZE | 1040mmL × 450mmD × 540mmH (1.2mm thickness) |



MTW 11 DRAWER TOOLBOX CABINET
Toolbox pairs with #15251

| | |
|-------------|---|
| CODE | 15252 |
| SIZE | 1056mmL × 460mmD × 1028mmH (1.2mm thickness) |



MTW 15 DRAWER TOOLBOX CABINET

| | |
|-------------|----------------------------|
| CODE | 12615 |
| SIZE | 1828mmL × 760mmD × 1143mmH |



MTW 18 DRAWER TOOLBOX CABINET

| | |
|-------------|---|
| CODE | 15253 |
| SIZE | 1828mmL × 760mmD × 1143mmH (1.2mm thickness) |



MTW 18 DRAWER TOOLBOX CABINET

| | |
|-------------|----------------------------|
| CODE | 12572-BLACK |
| SIZE | 1828mmL × 760mmD × 1143mmH |



MTW 18 DRAWER TOOLBOX CABINET

| | |
|-------------|----------------------------|
| CODE | 12572-BLUE |
| SIZE | 1828mmL × 760mmD × 1143mmH |



MTW 18 DRAWER TOOLBOX CABINET

| | |
|-------------|----------------------------|
| CODE | 12575-RED |
| SIZE | 1828mmL × 760mmD × 1143mmH |



**HANDLE FOR EASY MOVING
OR HANGING TOOLS ON**



INTERNAL LOCKING SYSTEM



PRE-CUT DRAWER LINERS

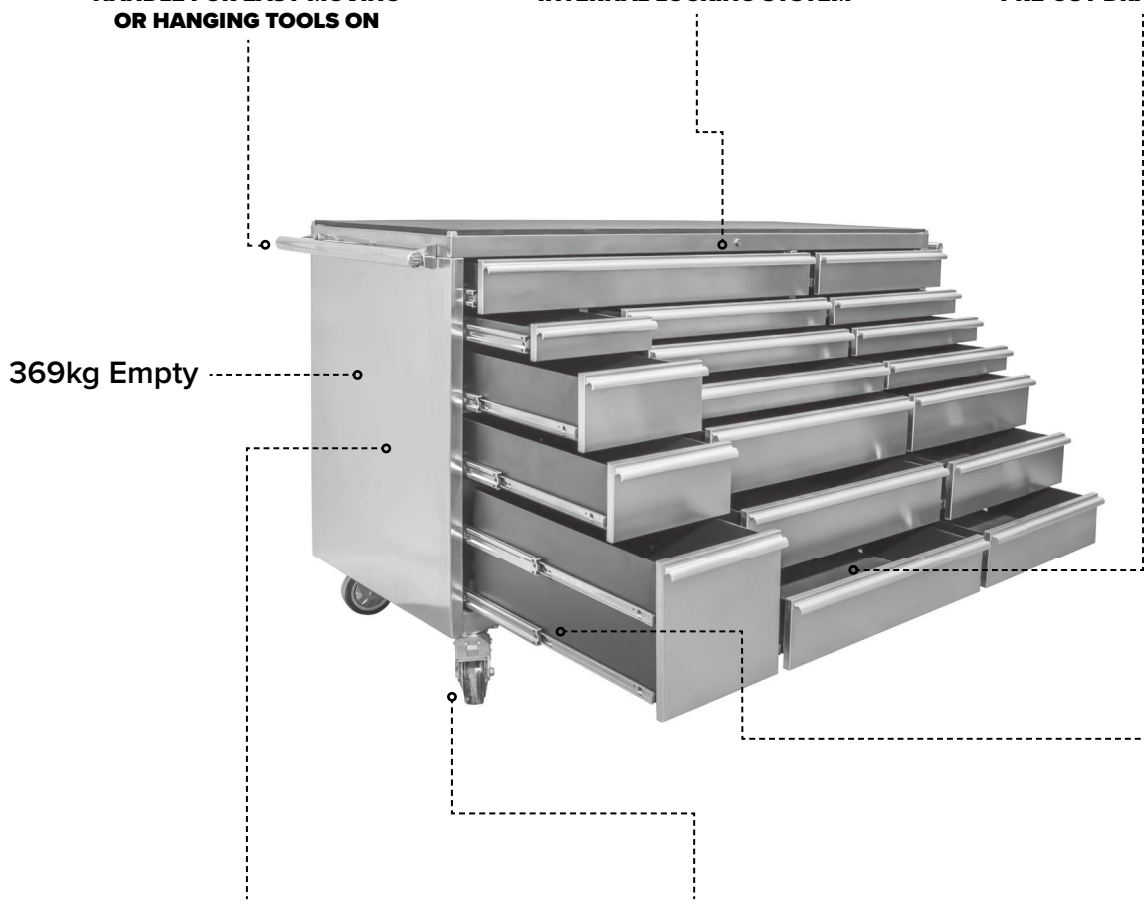

369kg Empty

#15253



**STAINLESS STEEL OR POWDER
COATED PAINT FINISH**



**6 HEAVY DUTY CASTOR
WHEELS ON EVERY TOOLBOX**



70KG RATED DRAWER RUNNERS

MTW WORKBENCHES

Available with 5 or 7 drawers, each workbench has adequate storage space and includes EVA foam drawer liners, ideal for a large tool collection. With a lock and two keys included, you'll be able to rest easy knowing your tools are safe. Both sizes are available in powder coated colours black, blue, and red.

- Load capacity of 1000kg: Strong and durable 3mm steel plate body, with reinforced 6mm steel plate corners for mounting vices or other tools.
- Designed in New Zealand for New Zealand conditions; long lasting, high quality, and a genuine product.



POWER POINT PANEL LOCATIONS



HEAVY DUTY DRAWER RUNNERS



PREDRILLED ACCESSORY MOUNTING POINTS



INTERNAL LOCKING SYSTEM



FOOT TABS TO SECURE TO FLOOR

**Plywood, vice and power points not included.*



MTW SMALL WORKBENCH

| | |
|-------------|----------------------------|
| CODE | 15305-2 |
| SIZE | 1630mmL × 816mmD × 1123mmH |



MTW SMALL WORKBENCH

| | |
|-------------|----------------------------|
| CODE | 15306-2 |
| SIZE | 1630mmL × 816mmD × 1123mmH |



MTW SMALL WORKBENCH

| | |
|-------------|----------------------------|
| CODE | 15307-2 |
| SIZE | 1630mmL × 816mmD × 1123mmH |



MTW LARGE WORKBENCH

| | |
|-------------|----------------------------|
| CODE | 15308-2 |
| SIZE | 2200mmL × 810mmD × 1100mmH |



MTW LARGE WORKBENCH

| | |
|-------------|----------------------------|
| CODE | 15309-2 |
| SIZE | 2200mmL × 810mmD × 1100mmH |



MTW LARGE WORKBENCH

| | |
|-------------|----------------------------|
| CODE | 15310-2 |
| SIZE | 2200mmL × 810mmD × 1100mmH |

WORKBENCH DIMENSIONS

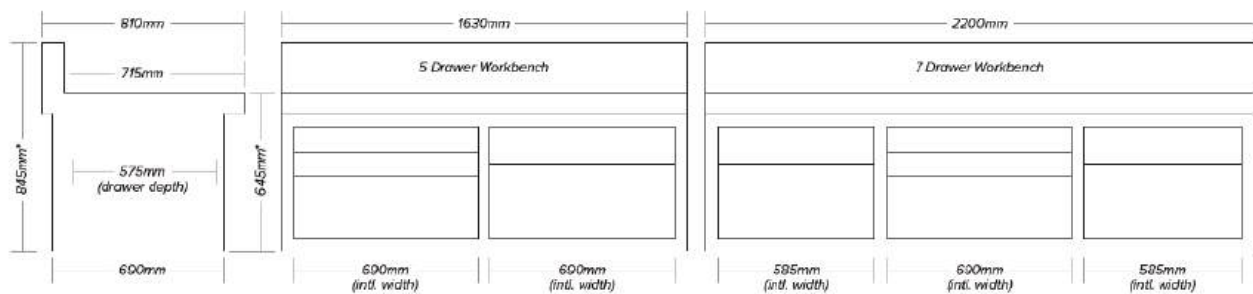

*Drawing heights shown represent the workbench bodies only - excluding the 278mm removable legs.

MIKES TRANSPORT WAREHOUSE

MTW SHADOW BOARDS

Suits our 2.2m & 1.6m Workbenches or can be wall mounted | Accessories sold separately.



#153224



MTW SHADOW BOARD

Red/Grey | Lockable | Lights, cables & plug

| | |
|-------------|---------------------------|
| CODE | 153224 |
| SIZE | 2200mmL × 228mmD × 770mmH |
| CODE | 153220 |
| SIZE | 1600mmL × 228mmD × 770mmH |



MTW SHADOW BOARD

Yellow/Grey | Lockable | Lights, cables & plug

| | |
|-------------|---------------------------|
| CODE | 153225 |
| SIZE | 2200mmL × 228mmD × 770mmH |
| CODE | 153221 |
| SIZE | 1600mmL × 228mmD × 770mmH |



SHADOW BOARD HALF ROUND 5MM SQUARE HOOK

Suits #15245, #15246, #15247

| | |
|-------------|---------------|
| CODE | 153235 |
| SIZE | 80mm Diameter |



SHADOW BOARD FLAT 5MM SQUARE HOOK

Suits #15000, #15001, #15002, #15003

| | |
|-------------|--------|
| CODE | 153234 |
| SIZE | 80mm |



SHADOW BOARD 12 HOOK SPANNER RACK

Suits #18010

| | |
|-------------|--------|
| CODE | 153236 |
|-------------|--------|



SHADOW BOARD 20 HOLE SCREWDRIVER RACK

Suits #18010

| | |
|-------------|--------|
| CODE | 153237 |
|-------------|--------|



SHADOW BOARD 6 SLOT PLIER RACK

Suits #18010

| | |
|-------------|--------|
| CODE | 153240 |
|-------------|--------|



SHADOW BOARD SPRAY PAINT TRAYS

#153241 is a single tray. #153242 is a double tray.

| | |
|-------------|-----------------|
| CODE | 153241 & 153242 |
| SIZE | 400x65mm |

MIKES TRANSPORT WAREHOUSE

MTW UTE TOOLBOXES

Tougher, more durable coatings. More impervious and corrosion resistant.



#15243



MTW POWDER COATED SERVICE UTE TOOLBOX
Shelves & Drawers

| | |
|-------------|---------------------------|
| CODE | 15243 |
| SIZE | 1400mmL x 600mmD x 900mmH |



MTW POWDER COATED SERVICE UTE TOOLBOX
No Shelves

| | |
|-------------|---------------------------|
| CODE | 15244 |
| SIZE | 1400mmL x 600mmD x 900mmH |



MTW POWDER COATED SERVICE UTE TOOLBOX

| | |
|-------------|---------------------------|
| CODE | 15260 |
| SIZE | 1550mmL × 700mmD × 945mmH |



MTW POWDER COATED DEEPDISH TOOLBOX

| | |
|-------------|--------------------------|
| CODE | 12900 |
| SIZE | 900mmL × 500mmD × 700mmH |



MTW POWDER COATED DEEPDISH TOOLBOX

| | |
|-------------|---------------------------|
| CODE | 15210 |
| SIZE | 1210mmL × 500mmD × 700mmH |



MTW POWDER COATED DEEPDISH TOOLBOX

| | |
|-------------|---------------------------|
| CODE | 11450 |
| SIZE | 1450mmL × 500mmD × 700mmH |



MTW POWDER COATED 3 DRAWER SERVICE CABINET

| | |
|-----------------------------|----------------------------------|
| CODE | 12603 |
| SIZE | 550mmL × 450mmD × 400mmH |
| MOUNTING | 460mmL × 360mmD (Hole Centres) |
| DRAWER INTERNAL SIZE | 465mmL × 395mmD × 75mmH |
| VOLUME | 41.25L total (13.75L Per Drawer) |
| DRAWER RUNNERS | 70kg Rated |



MTW POWDER COATED 5 DRAWER SERVICE CABINET

| | |
|-----------------------------|--------------------------------|
| CODE | 12605 |
| SIZE | 550mmL × 450mmD × 650mmH |
| MOUNTING | 460mmL × 360mmD (Hole Centers) |
| DRAWER INTERNAL SIZE | 465mmL × 395mmD × 90mmH |
| VOLUME | 82.5L total (16.5L Per Drawer) |
| DRAWER RUNNERS | 70kg Rated |

MTW UTE TOOLBOXES | MIKES TRANSPORT WAREHOUSE



MTW 5 DRAWER ALUMINIUM CHEQUER PLATE UTE TOOLBOX

Toolbox contains 5 drawers on the inside.

| | |
|-------------|---------------------------|
| CODE | 15241 |
| SIZE | 1400mmL × 500mmD × 700mmH |



MTW ALUMINIUM CHEQUER PLATE UTE TOOLBOX

Toolbox has an internal shelf.

| | |
|-------------|---------------------------|
| CODE | 15242 |
| SIZE | 1400mmL × 500mmD × 700mmH |



MTW ALUMINIUM CHEQUER PLATE UTE TOOLBOX

| | |
|-------------|--------------------------|
| CODE | 15755 |
| SIZE | 750mmL × 500mmD × 550mmH |



MTW ALUMINIUM CHEQUER PLATE DEEPDISH TOOLBOX

| | |
|-------------|--------------------------|
| CODE | 15550 |
| SIZE | 900mmL × 500mmD × 550mmH |



MTW ALUMINIUM CHEQUER PLATE DEEPDISH TOOLBOX

| | |
|-------------|--------------------------|
| CODE | 15900 |
| SIZE | 900mmL × 500mmD × 700mmH |



MTW ALUMINIUM CHEQUER PLATE DEEPDISH TOOLBOX

| | |
|-------------|---------------------------|
| CODE | 11150 |
| SIZE | 1150mmL × 500mmD × 700mmH |



MTW ALUMINIUM CHEQUER PLATE DEEPDISH TOOLBOX

| | |
|-------------|---------------------------|
| CODE | 111210 |
| SIZE | 1210mmL × 500mmD × 700mmH |



MTW ALUMINIUM CHEQUER PLATE DEEPDISH TOOLBOX

| | |
|-------------|---------------------------|
| CODE | 111500 |
| SIZE | 1500mmL × 500mmD × 700mmH |



#15550

MIKES TRANSPORT WAREHOUSE

MTW TRUCK & TRAILER TOOLBOXES

Perfect for keeping all your tools, load restrains, chains and packing organised and safe in your truck or trailer.



#15003



MTW UNDER DECK TOOLBOX

| | | |
|-------------|--------------------------|-------------------------|
| CODE | 15000 - Powder Coated | 15002 - Stainless Steel |
| SIZE | 900mmL x 430mmD x 350mmH | |



MTW UNDER DECK TOOLBOX

| | | |
|-------------|---------------------------|-------------------------|
| CODE | 15001 - Powder Coated | 15003 - Stainless Steel |
| SIZE | 1200mmL x 400mmD x 350mmH | |



MTW UNDER DECK TOOLBOX

| | |
|-------------|------------------------------|
| CODE | 18010 |
| SIZE | 1200mmL × 550mmD × 574.50mmH |

MTW UNDER DECK TOOLBOX

| | |
|-------------|--------------------------|
| CODE | 10918 |
| SIZE | 750mmL × 400mmD × 400mmH |

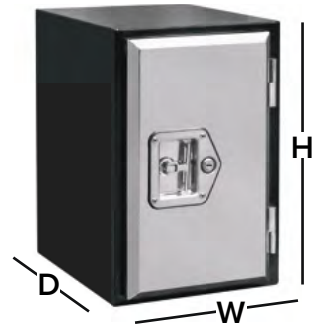

MTW UNDER DECK TOOLBOX

| | |
|-------------|--------------------------|
| CODE | 10951 |
| SIZE | 300mmL × 400mmD × 400mmH |

MTW UNDER DECK TOOLBOX

| | |
|-------------|--------------------------|
| CODE | 10516 |
| SIZE | 500mmL × 400mmD × 400mmH |

MTW LOGGING TRUCK TOOLBOX

| | |
|-------------|--------------------------|
| CODE | 15233 |
| SIZE | 400mmD × 300mmW × 450mmH |

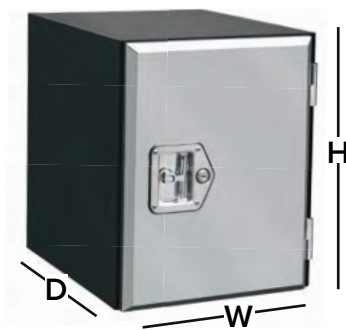

MTW LOGGING TRUCK TOOLBOX

| | |
|-------------|--------------------------|
| CODE | 15230 |
| SIZE | 500mmD × 400mmW × 500mmH |



***LOCKABLE T-LATCHES #13585**



MTW ANGLED UNDER DECK TOOLBOX

| | |
|-------------|--------------------------|
| CODE | 10911 |
| SIZE | 500mmL × 400mmD × 400mmH |



MTW ANGLED UNDER DECK TOOLBOX

| | |
|-------------|--------------------------|
| CODE | 10939 |
| SIZE | 750mmL × 400mmD × 400mmH |



MTW ANGLED UNDER DECK TOOLBOX

| | |
|-------------|--------------------------|
| CODE | 10917 |
| SIZE | 950mmL × 400mmD × 400mmH |



MTW ANGLED UNDER DECK TOOLBOX

| | |
|-------------|---------------------------|
| CODE | 110929 |
| SIZE | 1200mmL × 400mmD × 400mmH |



MTW DOUBLE OPENING TRUCK TOOLBOX

| | |
|-------------|---------------------------|
| CODE | 15244-BLACK |
| SIZE | 1256mmL × 600mmD × 604mmH |



MTW DOUBLE OPENING TRUCK TOOLBOX

| | |
|-------------|--------------------------|
| CODE | 15248-BLACK |
| SIZE | 806mmL × 600mmD × 604mmH |

**Accessories sold separately on page 19.*



#15255



MTW HORIZONTAL OPENING TOOLBOX

| | |
|-------------|---------------------------|
| CODE | 15255 |
| SIZE | 1254mmL × 584mmD × 552mmH |



MTW HORIZONTAL OPENING TOOLBOX

| | |
|-------------|---------------------------|
| CODE | 15246 |
| SIZE | 1502mmL × 584mmD × 522mmH |



MTW HORIZONTAL OPENING TOOLBOX

| | |
|-------------|---------------------------|
| CODE | 15247 |
| SIZE | 2004mmL × 634mmD × 602mmH |

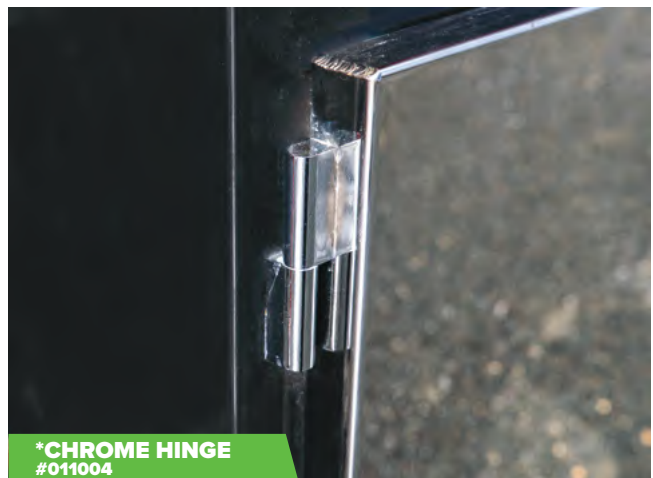

***CHROME HINGE**
#011004

**Accessories sold separately on page 19.*



#18021



MTW LINKWING TOOLBOX

| | |
|-------------|--------------------------|
| CODE | 18021 |
| SIZE | 682mmL × 357mmH × 263mmD |



MTW LINKWING TOOLBOX

| | |
|-------------|--------------------------|
| CODE | 18022 |
| SIZE | 682mmL × 387mmH × 163mmD |



MTW LINKWING TOOLBOX

| | |
|-------------|--------------------------|
| CODE | 18023 |
| SIZE | 300mmL × 300mmH × 320mmD |



MTW ALUMINIUM BODY & POLISHED STAINLESS STEEL DOOR TOOLBOX

Stainless Steel Door.

| | |
|-------------|--------------------------|
| CODE | 15262 |
| SIZE | 550mmL × 550mmD × 550mmH |



MTW ALUMINIUM BODY & BRUSHED FINISH ALUMINIUM DOOR TOOLBOX

Aluminium Door.

| | |
|-------------|--------------------------|
| CODE | 15263 |
| SIZE | 550mmL × 550mmD × 550mmH |



MTW ALUMINIUM BODY & POLISHED STAINLESS STEEL DOORS TOOLBOX

Stainless Steel Door.

| | |
|-------------|---------------------------|
| CODE | 15259 |
| SIZE | 1200mmL × 550mmD × 600mmH |



MTW ALUMINIUM BODY & BRUSHED FINISH ALUMINIUM DOORS TOOLBOX

Aluminium Door.

| | |
|-------------|---------------------------|
| CODE | 15254 |
| SIZE | 1200mmL × 550mmD × 600mmH |

**Accessories sold separately on page 19*

PARTS & ACCESSORIES



BLACK TOOLBOX DIVIDER
Suits toolboxes #15000 & #15001.

CODE 151060



STAINLESS TOOLBOX DIVIDER
Suits toolboxes #15002 & #15003.

CODE 151062



DRAWER SLIDERS/RUNNERS
Standard drawer sliders runners for MTW Toolboxes and Workbenches. Rated to 70 kg.

CODE 151062



TOOLBOX MOUNTING BRACKET
Suits #15245, #15246, #15247

CODE 151004
SIZE 1005mm x 620mm x 80mm

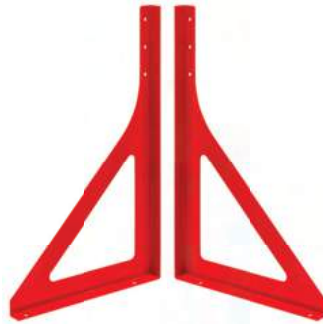

TOOLBOX MOUNTING BRACKET
Suits #15244-RED #015248-RED

CODE 151007
SIZE 1005mm x 620mm x 80mm



TOOLBOX MOUNTING BRACKET
Suits #15240 #15248-BLACK #15244-BLACK

CODE 151006
SIZE 1005mm x 620mm x 50mm



TOOLBOX MOUNTING BRACKET
*Use with #151005
Suits #15245, #15246, #15247

CODE 151004
SIZE 400mm x 165mm x 50mm



TOOLBOX MOUNTING BRACKET
*Use with #151007
Suits #15240 #15244-RED #15248-RED

CODE 151063
SIZE 165mm x 300mm x 50mm



TOOLBOX MOUNTING BRACKET
*Use with #151006
Suits #15240 #15244-BLACK #15248-BLACK

CODE 151061
SIZE 165mm x 300mm x 50mm



BLACK TOOLBOX SHELF

Suits #15245 & #15255

| | |
|-------------|-----------------------|
| CODE | 15256 |
| SIZE | 625mm × 310mm × 150mm |



BLACK TOOLBOX SHELF

Suits #15246

| | |
|-------------|-----------------------|
| CODE | 15257 |
| SIZE | 750mm × 310mm × 150mm |



BLACK TOOLBOX SHELF

Suits #15247

| | |
|-------------|------------------------|
| CODE | 15258 |
| SIZE | 1000mm × 310mm × 150mm |



TOOLBOX SHELF

| | | |
|-------------|----------------------|--------------------|
| CODE | 151075 | 151073 |
| | Suits #15248-RED | Suits #15248-BLACK |
| SIZE | 165mm × 300mm × 50mm | |

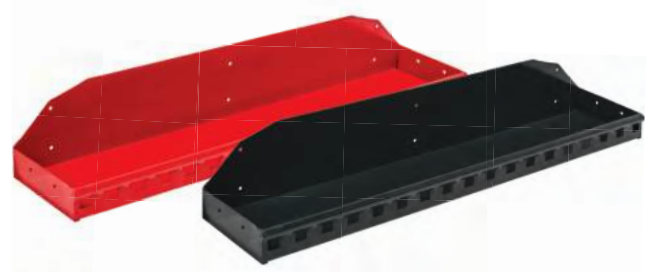

TOOLBOX SHELF

| | | |
|-------------|------------------------|--------------------|
| CODE | 151072 | 151071 |
| | Suits #15244-RED | Suits #15244-BLACK |
| SIZE | 1250mm × 270mm × 202mm | |



TOOLBOX TWITCH HOLDER

| | | |
|-------------|------------------------------|--|
| CODE | 151115 | 151114 |
| | Suits #15244-RED, #15248-RED | Suits #15240, #15244-BLACK, #15248-BLACK |
| SIZE | Fits standard twitch. | |



TOOLBOX MOUNTING PLATE

Suits #18016, #18017

| | |
|-------------|---------------|
| CODE | 151008 |
| SIZE | 285mm × 185mm |



TOOLBOX MOUNTING PLATE

Suits #15245, #15246, #15247

| | |
|-------------|---------------|
| CODE | 151002 |
| SIZE | 610mm x 200mm |



TOOLBOX MOUNTING PLATE

Suits #15000, #15001, #15002, #15003

| | |
|-------------|---------------|
| CODE | 151000 |
| SIZE | 450mm x 200mm |



TOOLBOX MOUNTING PLATE

Suits #18010

| | |
|-------------|---------------|
| CODE | 151001 |
| SIZE | 610mm x 200mm |



TOOLBOX T-LATCH

Lockable T-latch handle kit for toolboxes. Rubber cap for key barrel to keep water out. Includes 2 keys and gasket.

| | |
|-------------|-------|
| CODE | 13585 |
|-------------|-------|



TOOLBOX KEY & LOCK SET

| | |
|-------------|-------|
| CODE | 13586 |
|-------------|-------|



TOOLBOX COMPRESSION LATCH

| | |
|-------------|--------|
| CODE | 843437 |
|-------------|--------|



RUBBER SLIDE LOCATOR FOR TOOLBOX DRAWER SLIDES

| | |
|-------------|---------------|
| CODE | 12601 |
| SIZE | 450mm x 200mm |



BOLT-ON HINGE - CHROME

| | |
|-------------|---------------------|
| CODE | 011004 |
| SIZE | 80mm Long, 12mm Pin |



WELD-ON HINGE - STEEL

| | |
|-------------|--------------------|
| CODE | 190002 |
| SIZE | 80mm Long, 8mm Pin |



WELD-ON HINGE - STEEL

| | |
|-------------|----------------------|
| CODE | 190013 |
| SIZE | 150mm Long, 12mm Pin |



WELD-ON HINGE - ALUMINIUM

| | |
|-------------|--------------------|
| CODE | 190030 |
| SIZE | 80mm Long, 8mm Pin |



MTW STAINLESS LOGO
For Toolboxes & Workbenches

| | |
|-------------|----------------------------|
| CODE | 110895 |
| SIZE | 200mm L x 1.2mm W, 300mm H |



CASTOR WHEELS

| CODE | INCH | FIXED | SWIVEL | BRAKE | COLOUR |
|-------|------|-------|--------|-------|--------|
| 12804 | 4 | Yes | No | No | Red |
| 12800 | 6 | Yes | No | No | White |
| 12801 | 6 | No | Yes | Yes | White |
| 12802 | 6 | Yes | No | No | Black |
| 12803 | 6 | No | Yes | Yes | Black |
| 12805 | 4 | No | Yes | Yes | Red |



MTW GAS STRUTS

| CODE | LENGTH | STROKE | FORCE | TO SUIT |
|-------|--------|--------|-------|----------------------|
| 12560 | 292mm | 106mm | 140N | #15240, 15244, 15248 |
| 12564 | 345mm | 120mm | 120N | #15755 |
| 12563 | 345mm | 120mm | 140N | #12900 |
| 12562 | 480mm | 180mm | 80N | #15900 |
| 12561 | 480mm | 180mm | 140N | #12556 |
| 12565 | 505mm | 210mm | 250N | #15241 |



DRAWER SLIDERS

| CODE | LENGTH | TO SUIT |
|-------|--------|----------------------|
| 12551 | 10" | #15240, 15244, 15248 |
| 12566 | 16" | #15755 |
| 12553 | 20" | #12900 |
| 12559 | 20" | #15900 |
| 12557 | 20" | #12556 |
| 12558 | 20" | #15241 |
| 12554 | 28" | #15241 |



TOOLBOX DOORS

| CODE | DESCRIPTION | COMES WITH | TO SUIT |
|-------|--|------------------------------|---------|
| 12570 | Polished Stainless Toolbox Door (ONLY) | Door, Locks, Handle & Hinges | #15000 |
| 12571 | Polished Stainless Toolbox Door (ONLY) | Door, Locks, Handle & Hinges | #15001 |
| 15273 | Polished Stainless Toolbox Door (ONLY) | Door, Locks & Hinges | #15247 |
| 15281 | Polished Stainless Toolbox Door (ONLY) | Door, Handle & Hinges | #15255 |
| 15271 | Polished Stainless Toolbox Doors | 2 Doors, Locks & Hinges | #15246 |
| 15800 | Polished Stainless Toolbox Doors | 2 Doors, Locks & Hinges | #15255 |

