

WORKSHOP ESSENTIALS

CATALOGUE

CURRENT AS OF AUGUST 2024



MTW WORKSHOP ESSENTIALS

MTW WORKBENCHES

PERFECT FOR KEEPING ALL YOUR TOOLS ORGANISED AND SAFE.

The MTW workbenches have tough, heavy-duty bodies and are finished in gloss powder coating that looks fantastic.

Available with 5 or 7 drawers, each has huge storage space and included EVA foam drawer liners, ideal for a large tool collection. With a lock and two keys included, you'll be able to rest easy knowing your tools are safe. Also available in colours red, blue and black. The following points are features of our MTW workbenches.

- Durable gloss powder coating finish available in 3 bold colours.
- An extremely heavy duty construction: 5 drawer has an empty weight of 250kg; and the 7 drawer has an empty weight of 350kg.
- Load capacity of 1 tonne: 3mm steel plate body, with reinforced 6mm steel plate corners for mounting vices or other tools.
- Drawers have alloy handles and ball bearing sliders: small drawers have sliders rated for 70kg; the large drawer(s) have double sliders to accommodate for larger storage volume.
- Single lock barrel secures all bench drawers.

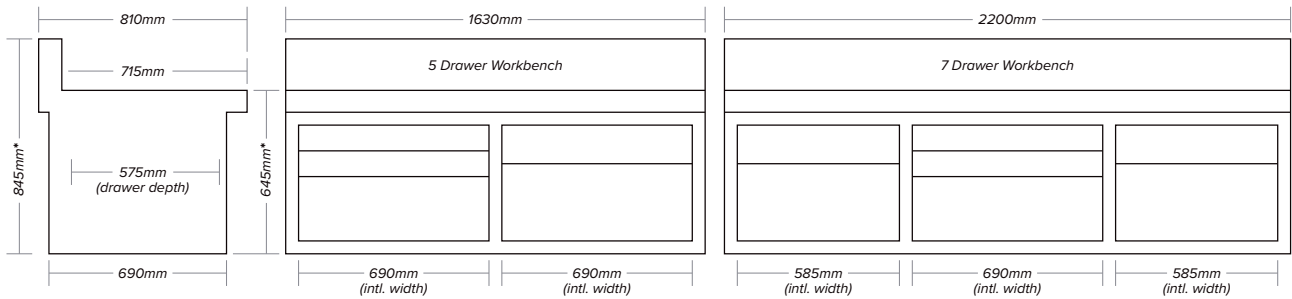

*Drawing heights shown represent the workbench bodies only - excluding the 278mm removable legs.



MTW WORKSHOP ESSENTIALS

15 DRAWER TOOL CABINET

CODE	COLOUR	TYPE
12615	Black	15 Drawer Bottom Cabinet Roller

Cabinet Dimensions: 1823mm x 760mm x 1143mm



MTW WORKSHOP ESSENTIALS
18 DRAWER TOOL CABINET



CODE	COLOUR	TYPE
12572-Red	Red	18 Drawer Bottom Cabinet Roller
12572-Blue	Blue	18 Drawer Bottom Cabinet Roller
12572-Black	Black	18 Drawer Bottom Cabinet Roller
15253	Stainless Steel	18 Drawer Bottom Cabinet Roller

MTW WORKSHOP ESSENTIALS
8 & 11 DRAWER TOOLBOX



CODE	COLOUR	TYPE
15251	Stainless Steel	8 Draw Top Chest
Chest Dimensions: 1040mm x 450mm x 540mm		
15252	Stainless Steel	11 Drawer Bottom Cabinet Roller
Cabinet Dimensions: 1056mm x 460mm x 1028mm		

MTW WORKSHOP ESSENTIALS
5 & 6 DRAWER TOOLBOX



CODE	COLOUR	TYPE
12598	Red	5 Drawer Top Chest
12597	Blue	5 Drawer Top Chest
12596	Black	5 Drawer Top Chest
12595	Red	6 Drawer Bottom Cabinet Roller
12594	Blue	6 Drawer Bottom Cabinet Roller
12593	Black	6 Drawer Bottom Cabinet Roller

MTW WORKSHOP ESSENTIALS
7 & 11 DRAWER TOOLBOX



CODE	COLOUR	TYPE
12556-	Red	7 Drawer Top Chest
12556-	Blue	7 Drawer Top Chest
12556-	Black	7 Drawer Top Chest
Chest Dimensions: 1423mm x 610mm x 533mm		
12556B-	Red	11 Drawer Bottom Cabinet Roller
12556B-	Blue	11 Drawer Bottom Cabinet Roller
12556B-	Black	11 Drawer Bottom Cabinet Roller
Cabinet Dimensions: 1423mm x 610mm x 1055mm		

MTW WORKSHOP ESSENTIALS

MTW SHADOW BOARDS



#153224

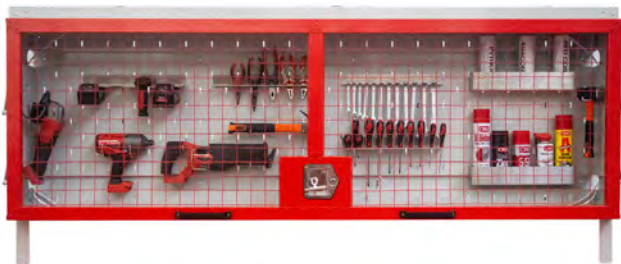

MTW SHADOW BOARD

Red/Grey | Lockable | Lights, cables & plug

CODE	153224
SIZE	2200mmL × 228mmD × 770mmH
CODE	153220
SIZE	1600mmL × 228mmD × 770mmH



MTW SHADOW BOARD

Yellow/Grey | Lockable | Lights, cables & plug

CODE	153225
SIZE	2200mmL × 228mmD × 770mmH
CODE	153221
SIZE	1600mmL × 228mmD × 770mmH

MTW SHADOW BOARD ACCESSORIES



SHADOW BOARD HALF ROUND 5MM SQUARE HOOK

CODE	153235
SIZE	80mm Diameter



SHADOW BOARD FLAT 5MM SQUARE HOOK

CODE	153234
SIZE	80mm

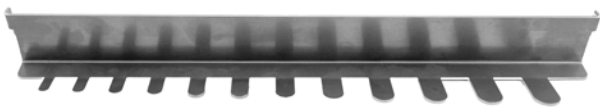

SHADOW BOARD 12 HOOK SPANNER RACK

CODE	153236
-------------	--------

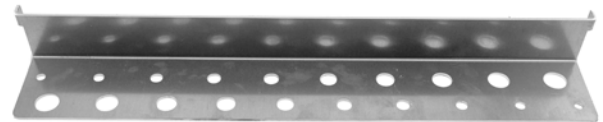

SHADOW BOARD 20 HOLE SCREWDRIVER RACK

CODE	153237
-------------	--------

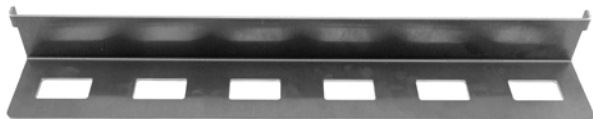

SHADOW BOARD 6 SLOT PLIER RACK

CODE	153240
-------------	--------



SHADOW BOARD SPRAY PAINT TRAYS

#153241 is a single tray. #153242 is a double tray.

CODE	153241 & 153242
SIZE	400x65mm

MTW WORKSHOP ESSENTIALS

ALUMINIUM DEEPDISH TOOLBOXES

- Ergonomic paddle latch system – easy for operators to open the door with an armload of tools!
- Lockable T-Lock latches – no more stolen tools!
- Full-length piano hinge on doors for added strength.
- Constructed entirely from high strength, marine grade aluminium for optimum durability, yet lightweight to maximise payload.
- Gutters and Rubber seals to maximise door width while providing a guaranteed dry environment for your valuable gear.
- Designed in New Zealand for New Zealand conditions.
- Gas strut assisted lid.

SPECIFICATIONS (Example photo, all look similar)

CODE	LENGTH	DEPTH	HEIGHT
15550	900mm	500mm	550mm
15900	900mm	500mm	700mm
11150	1150mm	500mm	700mm
011210	1210mm	500mm	700mm
011500	1500mm	500mm	700mm



MTW WORKSHOP ESSENTIALS

ALUMINIUM TOOLBOXES

SPECIFICATIONS (Example photo, all look similar)

CODE	LENGTH	DEPTH	HEIGHT	TYPE
015241	1400mm	500mm	700mm	Drawers
015242	1400mm	500mm	700mm	No Drawers



POWDER COATED

DEEPDISH TOOLBOXES



SPECIFICATIONS (Example photo, all look similar)

CODE	LENGTH	DEPTH	HEIGHT
12900	900mm	500mm	550mm
15210	1210mm	500mm	700mm
11450	1450mm	500mm	700mm

POWDER COATED

SERVICE CABINETS



SPECIFICATIONS (In order from left to right, as above)

CODE	LENGTH	DEPTH	HEIGHT
12603	550mm	450mm	400mm
12605	550mm	450mm	650mm

POWDER COATED

SERVICE UTE TOOLBOXES



SPECIFICATIONS (Example photo, all look similar)

CODE	LENGTH	DEPTH	HEIGHT	HEIGHT
15243	1400mm	600mm	900mm	Drawers
15244	1400mm	600mm	900mm	No Drawers

SPECIFICATIONS

CODE	LENGTH	DEPTH	HEIGHT	HEIGHT
15260	1550mm	700mm	945mm	No Drawers

MTW WORKSHOP ESSENTIALS METAL GRINDING DISCS



SPECIFICATIONS (In order from left to right, as above)

CODE	SIZE	MAX RPM
470621	230mm x 7mm x 22mm	6600
470619	180mm x 7mm x 22mm	850
470622	125mm x 7mm x 22mm	12200
470618	115mm x 7mm x 22mm	13300

MTW WORKSHOP ESSENTIALS METAL CUTTING DISCS



SPECIFICATIONS (In order from left to right, as above)

CODE	SIZE	MAX RPM
470617	180mm x 2.5mm x 22mm	8500
470611	125mm x 1.622mm x 22.2mm	12000
470616	115mm x 2.5mm x 22mm	13300
470628	115mm x 1.2mm x 22mm	13300
470629	75mm x 1.8mm x 22mm	20100

MTW WORKSHOP ESSENTIALS SANDING DISCS

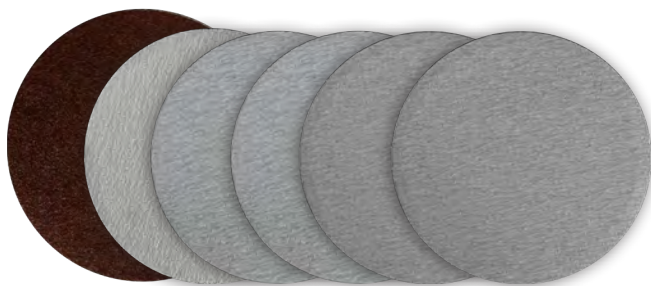

SPECIFICATIONS (In order from left to right, as above)

CODE	DIMENSIONS	SIZE
470623	P36 Grit	180mm
480886	P60 Grit	150mm
480883	P80 Grit	150mm
480884	P120 Grit	150mm
480885	P240 Grit	150mm

MTW WORKSHOP ESSENTIALS P60 GRIT FLAP

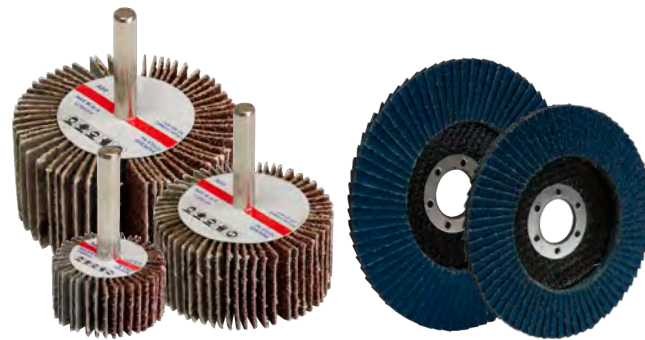

SPECIFICATIONS (In order from left to right, as above)

CODE	DIMENSIONS	MAX RPM	TYPE
470625	60mm x 30mm x 6mm	12700	Wheel
470626	50mm x 25mm x 6mm	15200	Wheel
470627	30mm x 15mm x 6mm	25400	Wheel
840019	125mm x 22mm	12200	Disc
470624	115mm x 22mm	13300	Disc

MODERN TRANSPORT ENGINEERS
HEAVY DUTY G-CLAMPS



SPECIFICATIONS

(Example photo, all look similar) (External Dimensions)

CODE	SIZE
848001	400mm x 200mm
8480021	300mm x 200mm
848006	300mm x 300mm

MTW WORKSHOP ESSENTIALS
CRANE SCALES OCS-XZ



SPECIFICATIONS (Example photo, all look similar)

CODE	CAPACITY	WEIGHT DIVISIONS
12020	3000kg	1kg
12021	5000kg	2kg
12022	10,000kg	5kg

ANCRA

LOAD BINDERS



SPECIFICATIONS (Example photos, all look similar)

PART NO.	11331	11339	11338	10339	10340	10338
CAPACITY	300kg	750kg	1500kg	2500kg	3000kg	5000kg
SIZE	38mm x 4.5m	25mm x 5m	35mm x 6m	50mm x 9m	50mm x 9m	75mm x 9m



**8MM RATCHET
MAXI BINDER / AUS BINDER**

CODE	15600
SIZE	3800kg



**10MM RATCHET
MAXI BINDER / AUS BINDER**

CODE	15601
SIZE	6000kg



ANCRA RATCHETING CARGO BAR

CODE	11310
SIZE	Adjusts from 1020-1770mm



**MTW 1040MM
PLASTIC CORNER BOARDS**

CODE	10091-MTW (Blue)
SIZE	1040mm x 140mm x 140mm
CODE	10095-MTW (Orange)
SIZE	1040mm x 140mm x 140mm



**MTW HEAVY DUTY
STEEL CORNER BOARDS**

CODE	10071 (Standard Steel)
SIZE	160mm x 100mm x 100mm
CODE	10080 (Steel & Rubber)
SIZE	160mm x 100mm x 100mm



**MTW 100MM
PLASTIC CORNER BOARD**

CODE	10098
SIZE	140mm x 100mm x 100mm

MTW WORKSHOP ESSENTIALS

LED HIGH BAY LIGHTS

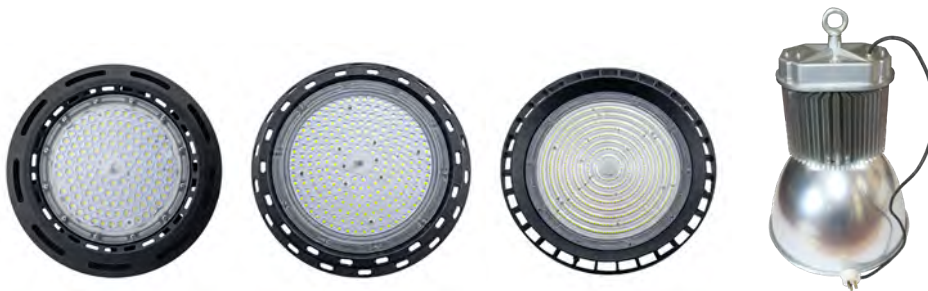

SPECIFICATIONS (Example photos, all look similar)

PART NO.	440036	440037	440038	440010
POWER	100W	150W	200W	150W
BEAM ANGLE	60°	60°	60°	90°



LED FLOOD LIGHTS

SPECIFICATIONS (In order from left to right, as above)

CODE	POWER	TYPE
440008	100W	Double Bulb
440009	180W	Triple Bulb



LED TUBE LIGHTS

SPECIFICATIONS (In order from left to right, as above)

CODE	POWER	TEMP	VOLTAGE
440005	20W	5000k	175-265V AC
440009	22W	5500k	175-265V AC

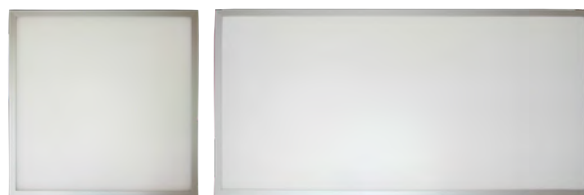

LED PANEL LIGHTS

SPECIFICATIONS (In order from left to right, as above)

CODE	POWER	SIZE
440011	30W	600mm x 600mm
440013	58W	600mm x 1200mm



LED TUBE FITTINGS

SPECIFICATIONS (In order from left to right, as above)

CODE	FITS	TYPE
440003	2x 1500mm tubes	Indoor
440002	2x 1500mm tubes	Outdoor



NZ'S LARGEST HAZARD GEAR RANGE!



LUCIDITY AMBER 9-36V LED BEACONS

CODE	436574
TYPE	Amber Lens - Surface Mount
CODE	436275
TYPE	Clear Lens - Surface Mount



HELLA 12V/24V LED AMBER MICRO LIGHT BARS

CODE	436016
TYPE	Amber Lens - Bracket Mount
CODE	436017
TYPE	Amber Lens - Magnetic Mount



E3 AMBER & PURPLE PILOT VEHICLE GRILL LIGHTS

CODE	436415
TYPE	Amber Lens - Surface Mount
CODE	436402
TYPE	Purple Lens - Surface Mount



*50mm x 45m Roll or Per m.

REFLECTIVE TAPE
(In order from left to right, as above)

CODE	COLOUR
432996	Yellow-Green
432995	Yellow & Black
432997	Yellow
432992	Orange
432990	Red & Silver
432994	Blue & Silver



DRY POWDER FIRE EXTINGUISHERS
(In order from left to right, as above)

CODE	SIZE	TYPE
12425	1kg	ABE
12412	2kg	ABE
12414	4.5kg	ABE
12416	9kg	ABE

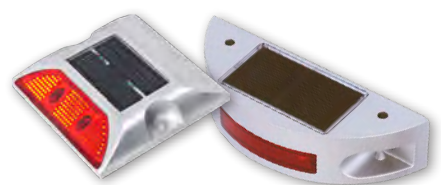

SOLAR POWERED NIGHT MARKER LIGHTS

CODE	436415
TYPE	Amber Lens - Surface Mount
CODE	436402
TYPE	Purple Lens - Surface Mount

MTW WORKSHOP ESSENTIALS

PLYWOOD ESSENTIALS

OKOUME PLYWOOD

Hardwood core. Suitable for furniture making, packing, wall linings & decorative work. Non-Treated.

PART NO.	SIZE
760071	2440mm x 1220mm x 6mm
760077	2440mm x 1220mm x 9mm
760078	2440mm x 1220mm x 12mm
760079	2440mm x 1220mm x 15mm
760076	2440mm x 1220mm x 18mm



ANTI-SLIP BIRCH PLYWOOD

Suitable for high-traffic, industrial applications. High wear resistance and anti-slip properties. Structural grade phenolic glue. designed for application such as vehicle floors, industrial flooring and load bearing platforms. Weather resistant when sealed.

PART NO.	SIZE
760095	2440mm x 1220mm x 18mm
480149	Plywood Sealer 500ml



BINTAGOR MERANTI PLYWOOD

Bold grain pattern. Suitable for furniture making, wall lining, packing and decorative work. Non-Treated.

PART NO.	SIZE
760072	2440mm x 1220mm x 6mm





RESTRAINT & HAZARD GEAR

GROUND PROTECTION MATS

Easy installation - No tools Required! Providing access over difficult terrain. Create temporary roadways for vehicles and equipment, perfect for industrial applications. Comfortably move pneumatic-wheeled equipment up to 80 tons.

MATERIAL	<i>High Density Polyethylene</i>
DIMENSIONS	12.7mm x 2440mm x 1100mm
CLEAT HEIGHT	7mm
COLOUR	Yellow
PATTERN	Chequer One Side, Hex One Side

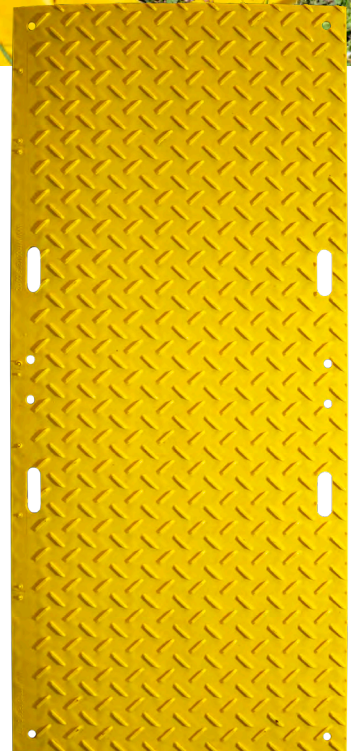

RESTRAINT & HAZARD GEAR

GROUND PROTECTION MATS

For muddy and flooded areas, mats should be linked with metal connectors. Each mat has connection holes that allow the mats to be connected side-by-side or at 90-degree angles.

THE MOST EFFECTIVE GROUND PROTECTION SYSTEM. EIGHT CONNECTION HOLES. ONE AT EACH CORNER. TWO ON EACH CENTER OF THE 8FT SIDE.





RESTRAINT & HAZARD GEAR

RADAR SPEED LIMIT SIGNS

MTW Solar Powered Radar Speed Limit Signs offer a high visibility, programmable speed display for use in a variable speed zone. The sign uses high intensity green and red LED display. Utilising the latest electronic hardware and software technology, the sign displays bright, clear and concise speed limits, variable at user's preference.

- Constructed with an industrial design for durability.
- Programmable in 5km increments.
- Transportable design.

SPECIFICATIONS

PART NO.	010384
SOLAR PANEL	100W 6.25A
SOLAR CHARGER	PWM 12/24V Auto Switch
BATTERY	AGM Deep Cycle Battery - Predator ED12850
BASE	H Pattern Forklift Compatible
SECURITY	Lockable Control Panel



MIKES TRANSPORT WAREHOUSE PRODUCT RANGE

ABRASIVES

Cutting Discs
Flap Discs
Flap Wheels
Grinding Discs
Sanding Discs

AD BLUE ADDITIVE

Ad Blue Magnets

AXLES & ACCESSORIES

Axle Hubs
Axle Spares
Bearings
Fixed Disc Axle
Fixed Drum Axle
Hub Caps
Steer Disc Axle
Steer Drum Axle

BATTERIES & ACCESSORIES

Jumpstarters

BODY HARDWARE

BRAKING

Air Brake Hose - Rubber
Air Brake Tube - Nylon
Brake Calipers
Brake Couplings
Brake Disc Pads
Brake Drums - Trailers
Brake Drums - Truck
Brake Kits
Brake Rotors
Brake Shoe Kits
Brake Shoes Lining & Accessories
Brake Valves
S-CAM / Bush Kits
Service Chambers
Slack Adjusters
Spring Brake Chambers
Suzi Coils - Air
Suzi Coils - Electrical

BRASS FITTINGS

CIRCLIPS

CHROME ACCESSORIES

Chrome Dress Rings
Chrome Hub Caps
Chrome Mud Flaps
Chrome Nut Covers
Chrome Other
Chrome Wheel Simulators

AD BLUE ADDITIVE

Califonia Custom
Chemtech
Cleaning Accessories
Renegade
Truckers Pride
Vikan Brushes
Wicked

DRAW BARS PARTS

Drawbar Bushes
Drawbar Hinges
Drawbar Pins
Drawbar Springs

ENERGY CHAIN

EXHAUST ACCESSORIES

Exhaust Clamps
Exhaust Connector Tubes
Exhaust Elbows
Exhaust Tube
Mufflers
Rain Caps

GREASE FITTINGS

Grease Guns
Grease Tubes

HAZARD

Fire Extinguishers
Gloves
Gloves - Welding
Hi-Vis Clothing
Safety Glasses
Signage

HEAVY EQUIPMENT

Komatsu Parts
Lonking Parts

Sumitomo Parts
Ensign Parts

HUBDOMETERS

HYDRAULIC HOISTS & ACCESSORIES

Diesel Power Packs
Electric Power Packs
Petrol Power Packs
Hoist - Burried Front Body
Hoist Brackets
Hoist Seal Kits
Hoist Spare Parts
Hose & Fittings
Hose Clamps
Hydraulic Pumps & Assemblies
Hydraulic Filler Caps
Hydraulic Return Filters
Hydraulics Tanks
Hydraulic Valves
PTO & Pumps
Sight Glasses

LANDING LEGS

Machinery Stands

LIGHTS & ELECTRICAL

Aerials
Brackets & Accessories
Bulbs
Cable
Cable Ties & Mounts
Commerical Lights
Driving & Fog Lamps
Headlamp Inserts
Switches/Relays & Horns
Marker Lights
Number Plate Lights
Plug & Sockets
Reflectors
Tail Lights
Terminals & Fuses
Warning Lights
Work lamps

MIRRORS

MIKES TRANSPORT WAREHOUSE PRODUCT RANGE

MTE TRAILER PARTS

MTE - 2 Axle Tilt Deck
MTE - 3 Axle Mech Suspension
MTE - Car Transporter
MTE - Deck Widener
MTE - Dolly
MTE - Forklift Trailer
MTE - House Trailer & Jacking
MTE - Linkwing
MTE - Modul
MTE - Other
MTE - Panel Trailer
MTE - Rows of 4
MTE - Simple Trailer
MTE - Tanker
MTE - Tipper

MUD FLAPS

Black & White Plastic
Black & White Rubber
Brackets / Bars
Custom

MUD GUARDS

Alloy Guards
Brackets / Saddles
Caps & Accessories
Plastic Guards
Poles
Stainless Guards

PLYWOODS

Antislip-Birch
HPL
Meranti-Bintangor
Okoume
Pine

PNEUMATIC CYLINDERS

RECOVERY & RESTRAINT GEAR

Chain & Twitches
Corner Boards
Lifting Slings
Load Binders
Shackles, Lashings & Hooks

SEALS

SMALL MOTORS

Kubota
Yanmar
Honda
Water Pumps

SMALL TRAILERS

Couplings
Coupling Locks
Jockey Wheels
Tow Balls & Accessories

SUSPENSION

Air Bags & Accessories - Trailer
Air Bags & Accessories - Truck
Alion Air Suspension Kits
Alion Air Suspensions Spares
Alion Spring Suspension Kits
Alion Spring Suspension Spares
K-Hitch Air Suspension Kits
K-Hitch Air Suspension Spares
K-Hitch Spring Suspension Kits
K-Hitch Spring Suspension Spares
Shock Absorbers
Spicer
Trailer Springs
U Bolts
All Suspension Brands Available.

TENG TOOLS

TOOLBOXES & ACCESSORIES

Toolbox Parts & Accessories
Truck & Trailer Toolboxes
Ute Toolboxes
Workbenches
Workshop Toolboxes

TANKS

Alloy/Stainless/Steel/Plastic
Air Tanks & Accessories
Cobination Oil & Fuel Tanks
Hydraulic Tanks & Accessories
Water Tanks & Accessories

TOW COUPLINGS

5th Wheels
Ballraces

Couplings & Pintle Hooks
Kin Pins
TCK Kits
Tow Eyes & Pintle Eyes

WHEELS

Alloy Wheels - Chrome
Alloy Wheels - Machined
Alloy Wheels - Polished
Alloy Wheels - Premium
Spacer Bands
Steel Rims
Steel Wheels
Steel Wheels - Chrome
Wheel Accessories
Wheel Nut Covers
Wheel Nut Indicators
Wheel Nuts
Wheel Studs

WINCHES

ATV Winches
Electric Winches
Hydraulic Winches

WIPER BLADES

Wiper Refills

WORKSHOP CONSUMABLES

Additives
Adhesives
CRC
Paint
Rags



